

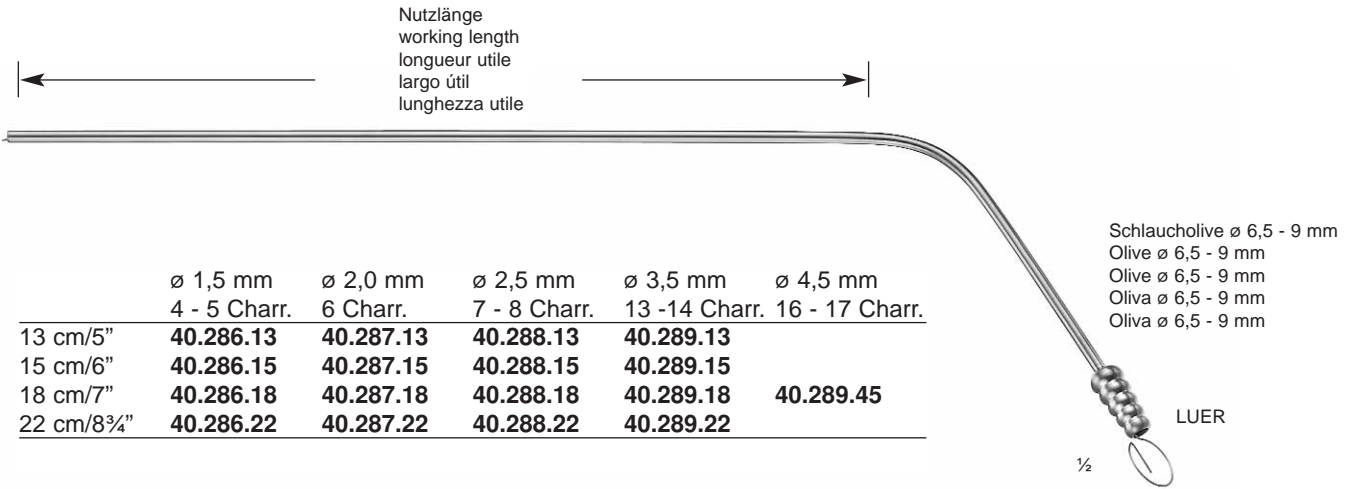

Saugrohre  
Suction Tubes  
Tubes d'aspiration  
Tubos de aspiración  
Tubi d'aspirazione



YASARGIL

Saugkanülen mit Unterbrecher und Mandrin  
Suction Cannulae with finger cut-off and stylet  
Canules d'aspiration avec interrupteur à doigt  
Cánulas para aspiración con interruptor y estilete  
Cannule per aspirazione con interruttore e stiletto

mit zentraler Bohrung  
with central bore  
avec trou central  
con un foro centrale  
con un agujero central

**04.148.27**  
ø 2,0 mm

**04.149.27**  
ø 4,8 mm

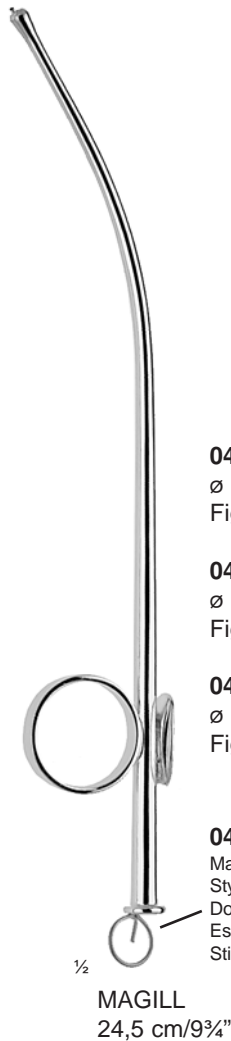

**04.155.30**  
ø 3,0 mm  
Fig. 1

**04.155.35**  
ø 3,5 mm  
Fig. 2

**04.155.40**  
ø 4,0 mm  
Fig. 3

**04.155.99**  
Mandrin  
Stylet  
Doigt  
Esfilete  
Stiletto

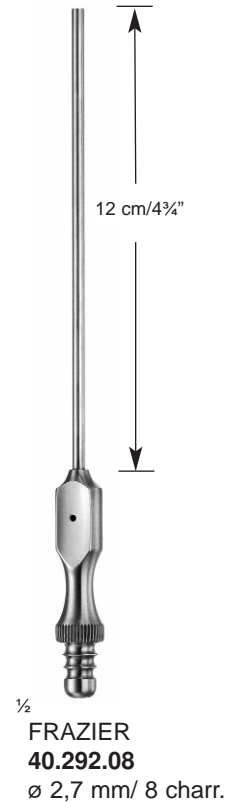

Saugrohre  
Suction Tubes  
Tubes d'aspiration  
Tubos de aspiración  
Tubi d'aspirazione

**dimeda**®

SURGICAL INSTRUMENTS

∅ 2 mm **40.283.02**  
∅ 3 mm **40.283.03**

Schlaucholive ∅ 7 - 9 mm  
Olive ∅ 7 - 9 mm  
Olive ∅ 7 - 9 mm  
Oliva ∅ 7 - 9 mm  
Oliva ∅ 7 - 9 mm



1/2

**LEMPERT**  
20 cm/8"

∅ mm	F.G. Charr.	11 cm/4 1/4"	13 cm/5"	16 cm/6 1/4"	20 cm/8"
∅ 1,5 mm	4 - 5	<b>40.270.15</b>	<b>40.271.15</b>	<b>40.272.15</b>	<b>40.273.15</b>
∅ 2,0 mm	6	<b>40.270.20</b>	<b>40.271.20</b>	<b>40.272.20</b>	<b>40.273.20</b>
∅ 2,5 mm	7 - 8	<b>40.270.25</b>	<b>40.271.25</b>	<b>40.272.25</b>	<b>40.273.25</b>
∅ 3,0 mm	9	<b>40.270.30</b>	<b>40.271.30</b>	<b>40.272.30</b>	<b>40.273.30</b>
∅ 4,0 mm	12	<b>40.270.40</b>	<b>40.271.40</b>	<b>40.272.40</b>	<b>40.273.40</b>
∅ 5,0 mm	15	<b>40.270.50</b>	<b>40.271.50</b>	<b>40.272.50</b>	<b>40.273.50</b>

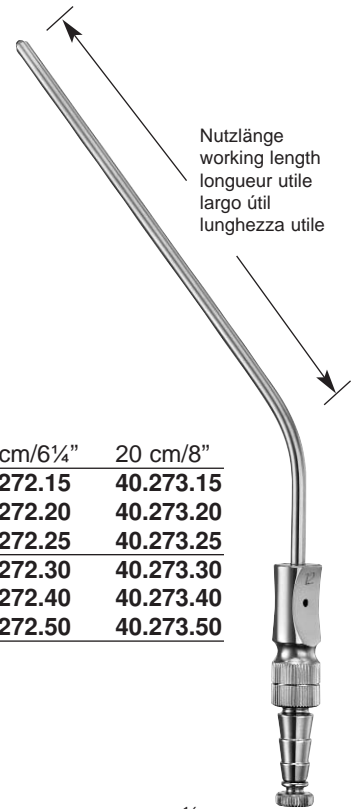

Nutzlänge  
working length  
longueur utile  
largo útil  
lunghezza utile

1/2

**FERGUSSON**

isoliert  
insulated  
isolée  
aislados  
isolato



1/2

**FERGUSSON**  
**40.291.04**  
18 cm/7"  
∅ 4 mm

Schlaucholive ∅ 6 - 9 mm  
Olive ∅ 6 - 9 mm  
Olive ∅ 6 - 9 mm  
Oliva ∅ 6 - 9 mm  
Oliva ∅ 6 - 9 mm

Saugkanülen mit Unterbrecher und Mandrin  
Suction Cannulae with finger cut-off and stylet  
Canules d'aspiration avec interrupteur à doigt  
Cánulas para aspiración con interruptor y estilete  
Cannule per aspirazione con interruttore e stiletto

F.G. Charr.	∅ mm	30°	75°
6	2,0	<b>40.295.06</b>	<b>40.297.06</b>
7	2,3	<b>40.295.07</b>	<b>40.297.07</b>
8	2,7	<b>40.295.08</b>	<b>40.297.08</b>
9	3,0	<b>40.295.09</b>	<b>40.297.09</b>
10	3,3	<b>40.295.10</b>	<b>40.297.10</b>
11	3,7	<b>40.295.11</b>	<b>40.297.11</b>
12	4,0	<b>40.295.12</b>	<b>40.297.12</b>
15	5,0	<b>40.295.15</b>	<b>40.297.15</b>



1/2

**FRAZIER**  
19 cm/7 1/2"



FRAZIER

6 Charr.	<b>40.293.06</b>
8 Charr.	<b>40.293.08</b>
9 Charr.	<b>40.293.09</b>
10 Charr.	<b>40.293.10</b>
12 Charr.	<b>40.293.12</b>

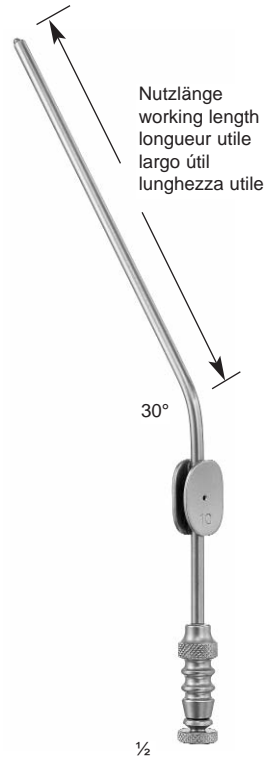

FRAZIER

F.G. Charr.	ø mm	12,5 cm/5"	18 cm/7"
6	2,0	<b>40.296.06</b>	<b>40.296.16</b>
8	2,7	<b>40.296.08</b>	<b>40.296.18</b>
10	3,3	<b>40.296.10</b>	<b>40.296.30</b>
12	4,0	<b>40.296.12</b>	<b>40.296.32</b>

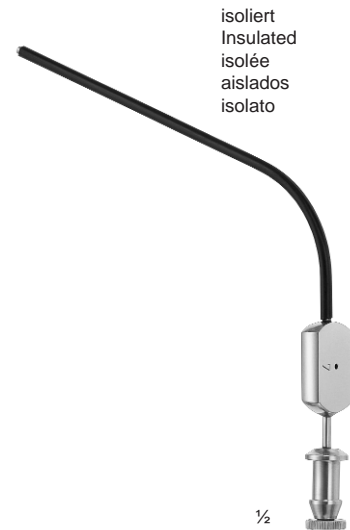

FRAZIER

19 cm/7½"	
7 charr.	<b>40.299.07</b>
9 charr.	<b>40.299.09</b>
11 charr.	<b>40.299.11</b>

Spitze 6,5 mm breit  
tip 6.5 mm wide  
6,5 mm de large  
6,5 mm de ancho  
6,5 mm di larghezza



**40.294.05**  
18 cm/7"  
ø 5 mm

Schlaucholive ø 6 - 9 mm  
Olive ø 6 - 9 mm  
Olive ø 6 - 9 mm  
Oliva ø 6 - 9 mm  
Oliva ø 6 - 9 mm



LUER  
17,5 cm/7"

ø 4,5 mm	<b>40.307.45</b>
ø 5,5 mm	<b>40.307.55</b>

Schlaucholive ø 6 - 9 mm  
Olive ø 6 - 9 mm  
Olive ø 6 - 9 mm  
Oliva ø 6 - 9 mm  
Oliva ø 6 - 9 mm

4-5 charr.	ø 1,5 mm	<b>40.313.15</b>
6 charr.	ø 2,0 mm	<b>40.313.20</b>
7-8 charr.	ø 2,5 mm	<b>40.313.25</b>
9 charr.	ø 3,0 mm	<b>40.313.30</b>

Schlaucholive ø 6 - 9 mm  
Olive ø 6 - 9 mm  
Olive ø 6 - 9 mm  
Oliva ø 6 - 9 mm  
Oliva ø 6 - 9 mm

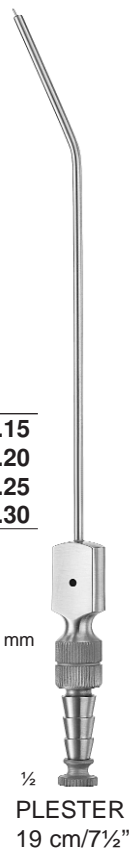

PLESTER  
19 cm/7½"

Hirnventrikelpunktionskanülen  
 Ventricle of cerebrum puncture cannulas  
 Canules pour la ponction des ventricules cérébraux  
 Cánulas para la punción del ventriculo cerebral  
 Cannule per la puntura del ventricolo cerebrale

**dimeda**®

SURGICAL INSTRUMENTS



**FRAZIER**  
 12 cm/4<sup>3</sup>/<sub>4</sub>"

∅ 2,0 mm	<b>40.298.08</b>
∅ 2,5 mm	<b>40.298.10</b>
∅ 3,0 mm	<b>40.298.12</b>

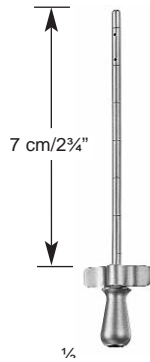

∅ 2,0 mm	<b>40.300.20</b>
∅ 2,5 mm	<b>40.300.25</b>



**CONE**  
 9 cm/3<sup>1</sup>/<sub>2</sub>"

12 G.	∅ 2,64 mm	<b>40.302.12</b>
13 G.	∅ 2,24 mm	<b>40.302.13</b>
14 G.	∅ 2,03 mm	<b>40.302.14</b>
15 G.	∅ 1,83 mm	<b>40.302.15</b>
16 G.	∅ 1,62 mm	<b>40.302.16</b>
17 G.	∅ 1,42 mm	<b>40.302.17</b>
18 G.	∅ 1,22 mm	<b>40.302.18</b>
20 G.	∅ 0,91 mm	<b>40.302.20</b>

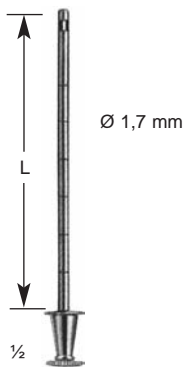

**JEFFERSON**

8 cm/3 <sup>1</sup> / <sub>4</sub> "	<b>40.301.08</b>
10 cm/4"	<b>40.301.10</b>

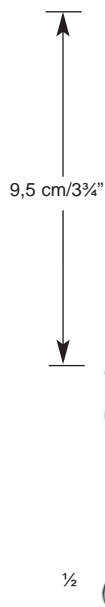

**DANDY**

∅ 2,0 mm	<b>40.303.20</b>
----------	------------------

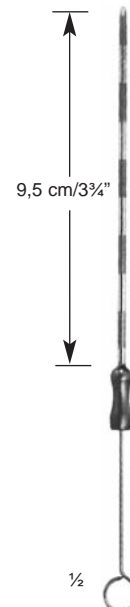

**CUSHING-CAIRNS**

∅ 2,3 mm	<b>40.304.23</b>
∅ 2,6 mm	<b>40.304.26</b>



1/2

**ZOELLNER**  
**40.283.70**  
18 cm/7"



**ZOELLNER**  
5,5 cm/2"

ø 1,2 mm / 18 swg	<b>40.283.71</b>
ø 1,0 mm / 20 swg	<b>40.283.72</b>
ø 0,7 mm / 22 swg	<b>40.283.73</b>
ø 0,5 mm / 24 swg	<b>40.283.74</b>
ø 0,4 mm / 26 swg	<b>40.283.75</b>

Schlaucholive ø 8 mm  
Olive ø 8 mm  
Olive ø 8 mm  
Oliva ø 8 mm  
Oliva ø 8 mm



1/2

**WULLSTEIN**

**40.308.00**

Komplett, mit Griff und drei Ausfätzen  
complete, with handle and 3 tips  
complet, avec manche et 3 pointes  
completo, con mango y 3 puntas  
completo, con manico e 3 punte

**40.308.01**

14 cm/5 1/2"

Saugerhandgriff  
Suction Handle  
Manche pour canule  
Mango para cánula  
Manico d'aspirazione

Mikro-Saugkanüle  
Micro suction cannula  
Tube micro d'aspiration  
Micro tubo de aspiración  
Micro-cannula d'aspirazione



**40.308.04**  
4,5 cm/1 3/4"  
ø 0,4 mm

**40.308.06**  
4,5 cm/1 3/4"  
ø 0,6 mm

**40.308.08**  
4,5 cm/1 3/4"  
ø 0,8 mm

**40.309.00**

Komplett, mit Griff und 4 Ausfätzen (x 2)  
complete, with handle and 4 tips (x 2)  
complet, avec manche et 4 pointes (x 2)  
completo, con mango y 4 puntas (x 2)  
completo, con manico e 4 punte (x 2)



**40.309.01**

Saugerhandgriff  
Suction Handle  
Manche pour canule  
Mango para cánula  
Manico d'aspirazione



ø 0,5 mm	<b>40.309.02</b>
ø 0,7 mm	<b>40.309.03</b>
ø 1,0 mm	<b>40.309.04</b>
ø 1,3 mm	<b>40.309.05</b>



**BELLUCCI**  
**40.310.00**

Komplett, mit Griff und drei Ausfätzen  
complete, with handle and 3 tips  
complet, avec manche et 3 pointes  
completo, con mango y 3 puntas  
completo, con manico e 3 punte

Schlaucholive ø 8 mm  
Olive ø 8 mm  
Olive ø 8 mm  
Oliva ø 8 mm  
Oliva ø 8 mm

ø 1,0 mm / 20 swg	<b>40.310.02</b>
ø 0,7 mm / 22 swg	<b>40.310.03</b>
ø 0,5 mm / 24 swg	<b>40.310.04</b>

**BELLUCCI**  
**40.310.01**  
15,5 cm/6"

mit Saugunterbrecher und Mandrin  
 with finger cut-off and stylet  
 avec interrupteur à doigt  
 con interruptor y estilete  
 con interruttore e stiletto

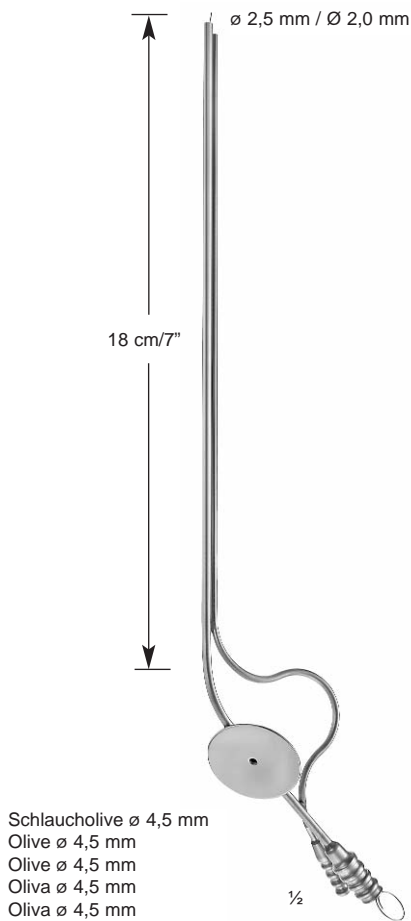

**FISCH**  
**40.331.17**

Saug- und Spülkanüle  
 Suction and Irrigation Cannula  
 Instruments à aspiration et à irrigation  
 Instrumentos de aspiración y de lavado  
 Strumenti per aspirazione e lavaggio



**YASARGIL**  
**40.332.20**  
 20 cm/8"  
 Ø 2,0/4,5 mm

Präpariersauger  
 Suction raspatory  
 Aspirateur pour préparation  
 Aspirador para preparación  
 Aspiratore per preparazione



**LANDOLT**  
**40.333.20**  
 20 cm/8"  
 Ø 3,2 mm

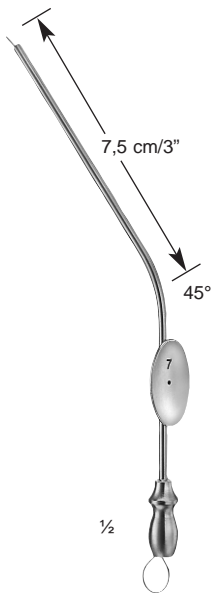

BARON

mit Unterbrecher  
with finger cut-off  
avec plaque interrupteur  
con placa desconectadora  
con placa interruttore

○  
**44.101.03**  
ø 1,0 mm

◉  
**44.101.05**  
ø 1,5 mm

⊙  
**44.101.07**  
ø 2,0 mm



SCHUHKNIGHT  
13 cm/5"

Schlaucholive ø 8 mm  
Olive ø 8 mm  
Olive ø 8 mm  
Oliva ø 8 mm  
Oliva ø 8 mm

Saugadapter mit Saugunterbrecher  
Suction adapter with finger cut-off  
Adaptateur d'aspiration avec interrupteur  
Adaptador para aspiración con interruptor  
Adattator per aspirazione con interruttore



HOUSE  
**44.104.00**  
5,5 cm/2 1/4"

Schlaucholive ø 7 mm  
Olive ø 7 mm  
Olive ø 7 mm  
Oliva ø 7 mm  
Oliva ø 7 mm

ø 0,9 mm / 20 swg	<b>44.102.20</b>
ø 0,6 mm / 24 swg	<b>44.102.24</b>

Saugrohr  
suction tube  
à aspiration  
de aspiración  
per aspirazione

Spülrohr  
irrigation tube  
à irrigation  
de lavado  
per lavaggio

ø 1,8 mm	ø 1,8 mm	<b>44.103.01</b>
ø 2,0 mm	ø 2,0 mm	<b>44.103.02</b>
ø 3,0 mm	ø 2,0 mm	<b>44.103.03</b>
ø 4,5 mm	ø 2,0 mm	<b>44.103.04</b>
ø 0,9 mm	ø 0,7 mm	<b>44.103.11</b>
ø 1,2 mm	ø 0,9 mm	<b>44.103.12</b>
ø 1,5 mm	ø 1,2 mm	<b>44.103.13</b>

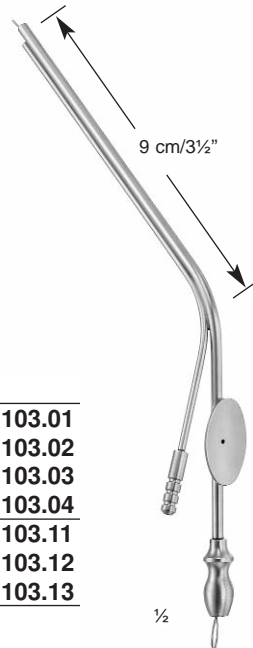

HOUSE

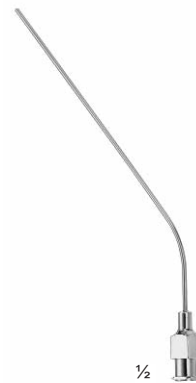

VERHOEVEN  
10 cm/4"

ø 1,6 mm / 16 swg	<b>44.105.16</b>
ø 1,2 mm / 18 swg	<b>44.105.18</b>
ø 0,9 mm / 20 swg	<b>44.105.20</b>
ø 0,7 mm / 22 swg	<b>44.105.22</b>
ø 0,6 mm / 24 swg	<b>44.105.24</b>