

54

Tracheotomie, Kropf
Tracheostomy, Goitre
Trachéotomie, Goitre
Traqueotomía, Bocio
Tracheotomia, Gozzo

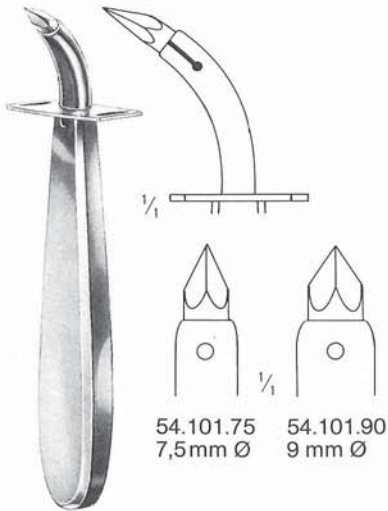

UCKERMANN
 54.101.75-54.101.90
 13 cm

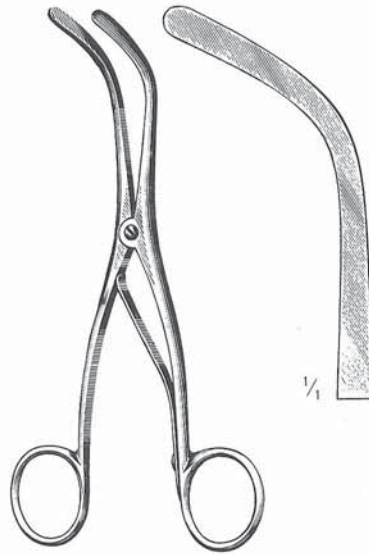

TROUSSEAU
 54.111.14
 14 cm

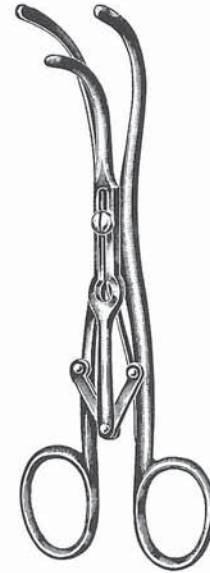

LABORDE
 54.113.14
 14 cm



BOSE
 54.115.07
 7 cm



JACKSON
 54.116.15
 15 cm

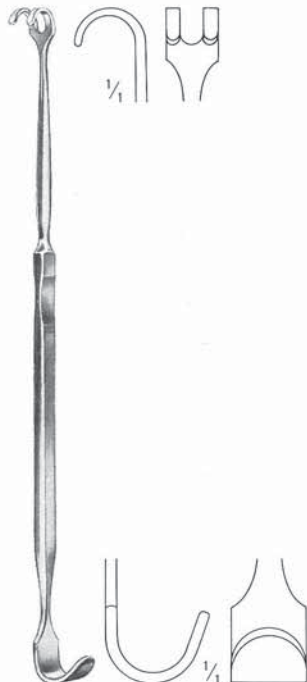

JACKSON
 54.117.17
 17 cm



ITERSON
 54.118.16-54.119.16
 16 cm

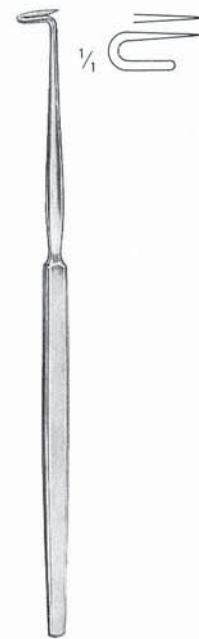

BOSE
 54.122.16
 16 cm



BOSE
 54.124.16
 16 cm

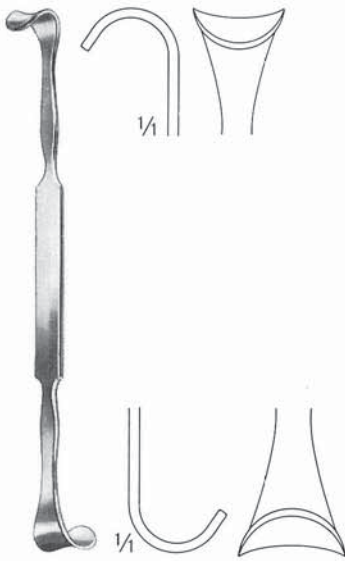

ROSE
54.130.13
13 cm



mm	WAGENER-MOSHER
5	54.151.05
7	54.151.07
9	54.151.09

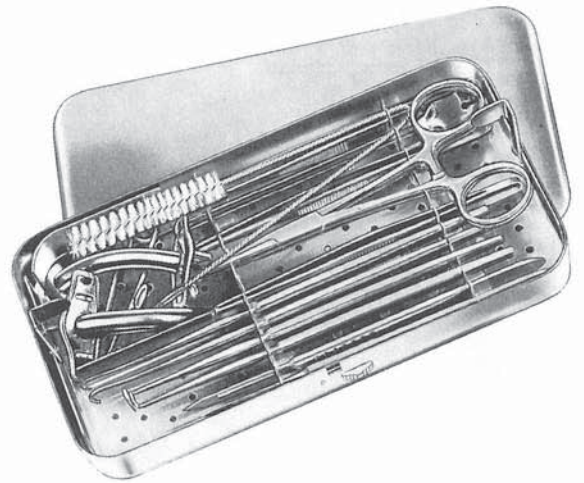

54.270.00



Fig.	mm	LUER
0	4	54.220.04
1	5	54.220.05
2	6	54.220.06
3	7	54.220.07
4	8	54.220.08
5	9	54.220.09
6	10	54.220.10
7	11	54.220.11
8	12	54.220.12
9	13	54.220.13



Fig.	mm	JACKSON
0	4	54.240.04
1	5	54.240.05
2	6	54.240.06
3	7	54.240.07
4	8	54.240.08
5	9	54.240.09
6	10	54.240.10
7	11	54.240.11
8	12	54.240.12
9	13	54.240.13

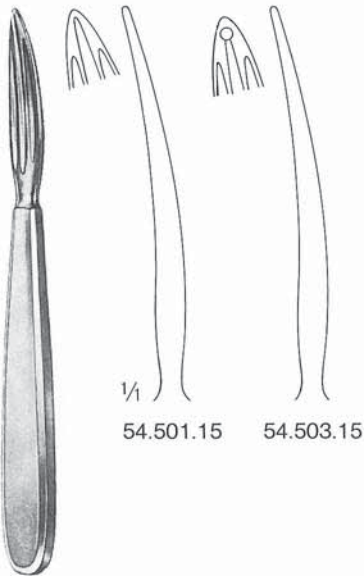

54.501.15

54.503.15

KOCHER
54.501.15-54.503.15
15 cm



SCHOENBORN
54.511.21
21 cm



cm	LAHEY
15	54.520.15
20	54.520.20

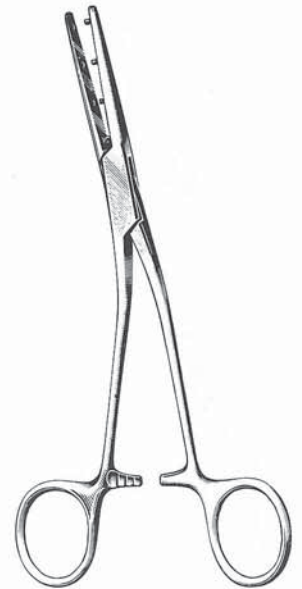

MASTIN
54.523.17
17 cm