

Pinzetten

Thumb and Tissue Forceps

Pinces à dissection

Pinzas de disección

Pinze per dissezione

Pinzetten  
 Thumb and Tissue Forceps  
 Pincés à dissection  
 Pinzas de disección  
 Pinze per dissezione

**dimed**<sup>®</sup>

SURGICAL INSTRUMENTS

schmal  
 narrow  
 étroite  
 estrecha  
 stretta



11,5 cm/4½"	<b>10.102.11</b>	<b>10.110.11</b>
13 cm/5"	<b>10.102.13</b>	<b>10.110.13</b>
14,5 cm/5¾"	<b>10.102.14</b>	<b>10.110.14</b>
16 cm/6¼"	<b>10.102.16</b>	<b>10.110.16</b>
18 cm/7"	<b>10.102.18</b>	<b>10.110.18</b>
20 cm/8"	<b>10.102.20</b>	<b>10.110.20</b>
25 cm/10"	<b>10.102.25</b>	<b>10.110.25</b>
30 cm/12"	<b>10.102.30</b>	<b>10.110.30</b>

Mit TC-Einsätzen  
 with TC inserts  
 A mors TC  
 Con bocas TC  
 Con morso TC

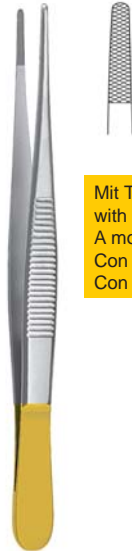

14,5 cm/5¾"	<b>10.114.14</b>
16 cm/6¼"	<b>10.114.16</b>

Mit TC-Einsätzen  
 with TC inserts  
 A mors TC  
 Con bocas TC  
 Con morso TC



POTTS-SMITH

15,5 cm/6"		<b>10.116.15</b>
18 cm/7"	<b>10.112.18</b>	<b>10.116.18</b>
20 cm/8"		<b>10.116.20</b>
21 cm/8¼"	<b>10.112.21</b>	<b>10.116.21</b>
23 cm/9"		<b>10.116.23</b>
25 cm/10"	<b>10.112.25</b>	<b>10.116.25</b>
30 cm/12"	<b>10.112.30</b>	

1:2



1:2



schmal  
 narrow  
 étroite  
 estrecha  
 stretta

11,5 cm/4½"	<b>10.120.11</b>	<b>10.130.11</b>
13 cm/5"	<b>10.120.13</b>	<b>10.130.13</b>
14,5 cm/5¾"	<b>10.120.14</b>	<b>10.130.14</b>
16 cm/6¼"	<b>10.120.16</b>	<b>10.130.16</b>
18 cm/7"	<b>10.120.18</b>	<b>10.130.18</b>
20 cm/8"	<b>10.120.20</b>	<b>10.130.20</b>
23 cm/9"	<b>10.120.23</b>	
25 cm/10"	<b>10.120.25</b>	<b>10.130.25</b>
30 cm/12"	<b>10.120.30</b>	<b>10.130.30</b>

1:2



mittel  
 medium  
 milieu  
 medio  
 mezzo

13 cm/5"	<b>10.131.13</b>
14,5 cm/5¾"	<b>10.131.14</b>

2:3



11,5 cm/4½"	<b>10.140.11</b>
13 cm/5"	<b>10.140.13</b>
14,5 cm/5¾"	<b>10.140.14</b>
16 cm/6¼"	<b>10.140.16</b>
18 cm/7"	<b>10.140.18</b>
20 cm/8"	<b>10.140.20</b>
25 cm/10"	<b>10.140.25</b>

1:2



POTTS-SMITH

18 cm/7"	<b>10.126.18</b>
21 cm/8¼"	<b>10.126.21</b>
25 cm/10"	<b>10.126.25</b>
40 cm/16"	<b>10.126.40</b>

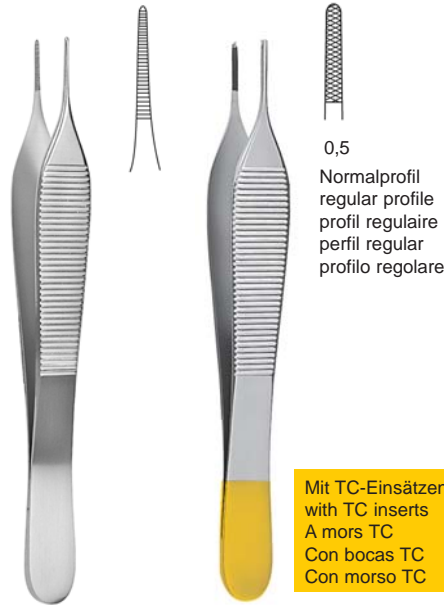

0,5  
 Normalprofil  
 regular profile  
 profil regulaire  
 perfil regular  
 profilo regolare

Mit TC-Einsätzen  
 with TC inserts  
 A mors TC  
 Con bocas TC  
 Con morso TC

ADSON

12 cm/4¾"	10.170.12	10.174.12
15 cm/6"	10.170.15	10.174.15
18 cm/7"	10.170.18	



ADSON micro

12 cm/4¾"	10.176.12
15 cm/6"	10.176.15

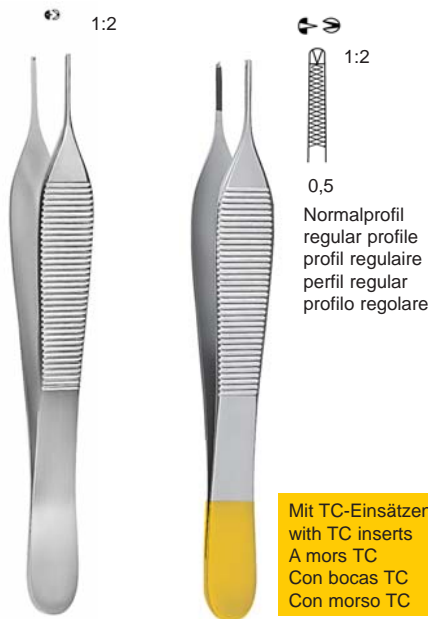

0,5  
 Normalprofil  
 regular profile  
 profil regulaire  
 perfil regular  
 profilo regolare

Mit TC-Einsätzen  
 with TC inserts  
 A mors TC  
 Con bocas TC  
 Con morso TC

ADSON

12 cm/4¾"	10.180.12	10.184.12
15 cm/6"	10.180.15	10.184.15
18 cm/7"	10.180.18	

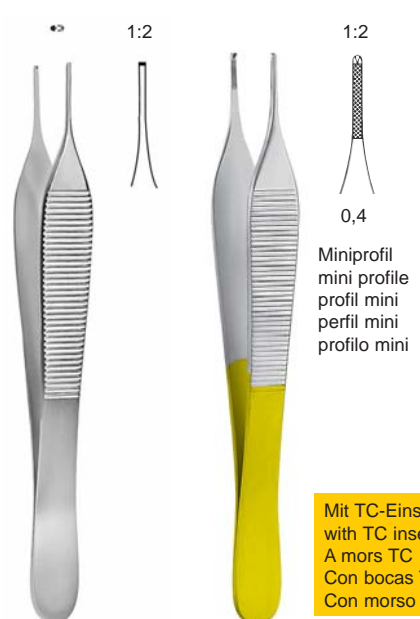

0,4  
 Miniprofil  
 mini profile  
 profil mini  
 perfil mini  
 profilo mini

Mit TC-Einsätzen  
 with TC inserts  
 A mors TC  
 Con bocas TC  
 Con morso TC

ADSON micro

12 cm/4¾"	10.186.12	10.173.12
15 cm/6"	10.186.15	10.173.15
18 cm/7"	10.186.18	

kreuzgerieft  
 cross serrated  
 mors stries  
 boca estriada  
 e zigrinata

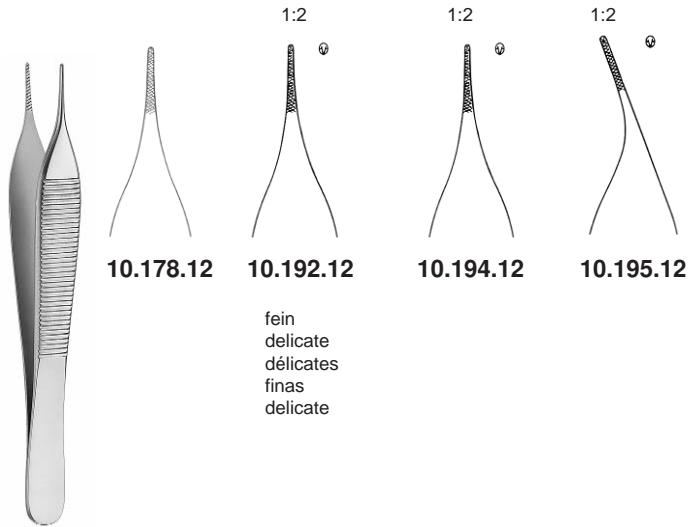

**ADSON**  
 12 cm/4¾"

fein  
 delicate  
 délicates  
 finas  
 delicate

1:2

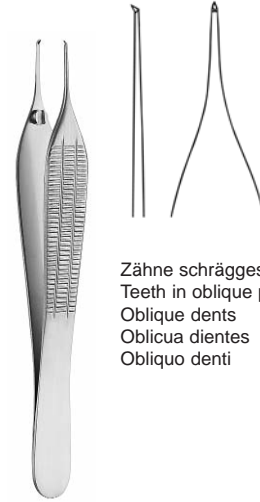

**ADSON-BIEMER**  
**10.187.12**  
 12 cm/4¾"

Zähne schräggestellt  
 Teeth in oblique position  
 Oblique dents  
 Oblicua dentes  
 Obliquo denti

kreuzgerieft  
 cross serrated  
 mors stries  
 boca estriada  
 e zigrinata

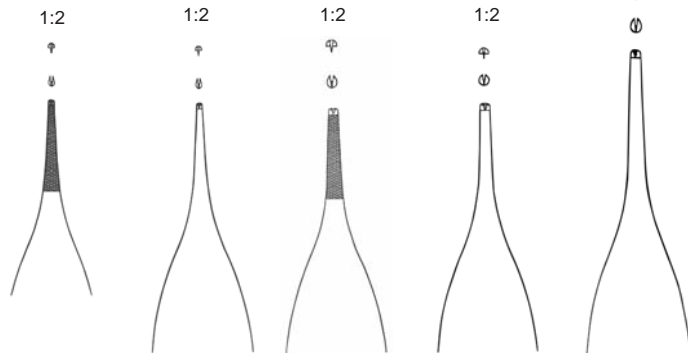

**10.191.12**  
 12 cm/4¾"

**10.196.12**  
 12 cm/4¾"

**10.197.12**  
 12 cm/4¾"

**10.198.12**  
 12 cm/4¾"

**10.198.15**  
 15 cm/6"

fein  
 delicate  
 délicates  
 finas  
 delicate

**ADSON**

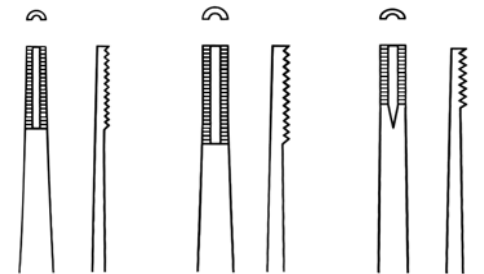

**10.189.16**  
 15 cm/6"

**10.189.20**  
 20 cm/8"

**10.189.25**  
 25 cm/10"

**BROWN**

Pinzetten  
 Thumb and Tissue Forceps  
 Pincès à dissection  
 Pinzas de disección  
 Pinze per dissezione

**dimed**®

SURGICAL INSTRUMENTS

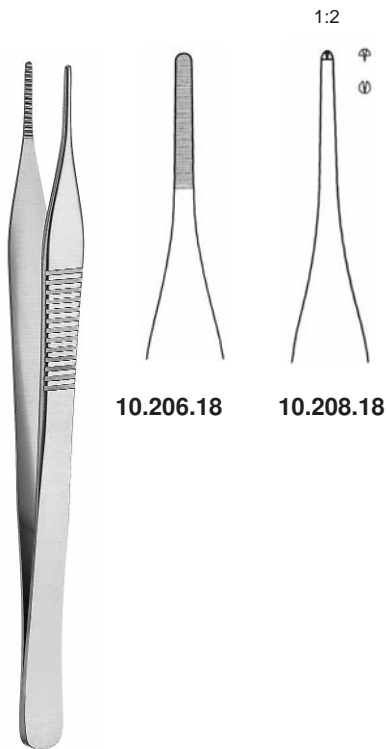

10.206.18

10.208.18

JEFFERSON  
 18 cm/7"

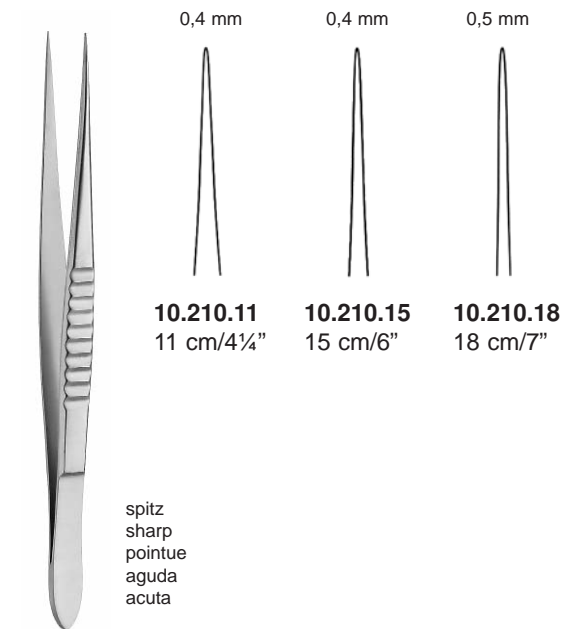

10.210.11  
 11 cm/4¼"

10.210.15  
 15 cm/6"

10.210.18  
 18 cm/7"

spitz  
 sharp  
 pointue  
 aguda  
 acuta

JACOBSON

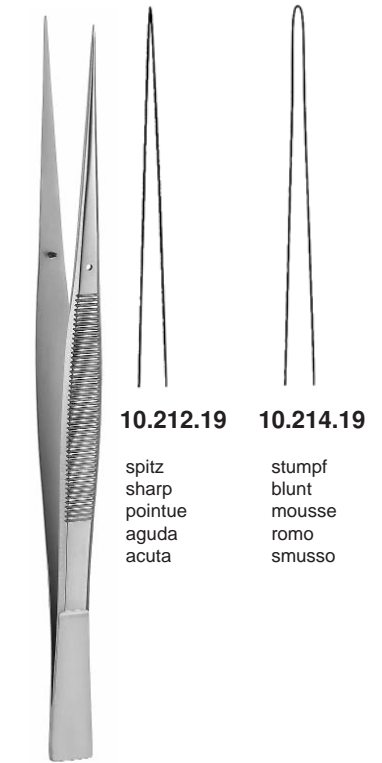

10.212.19

10.214.19

spitz  
 sharp  
 pointue  
 aguda  
 acuta

stumpf  
 blunt  
 mousse  
 romo  
 smusso

19,5 cm/7¾"

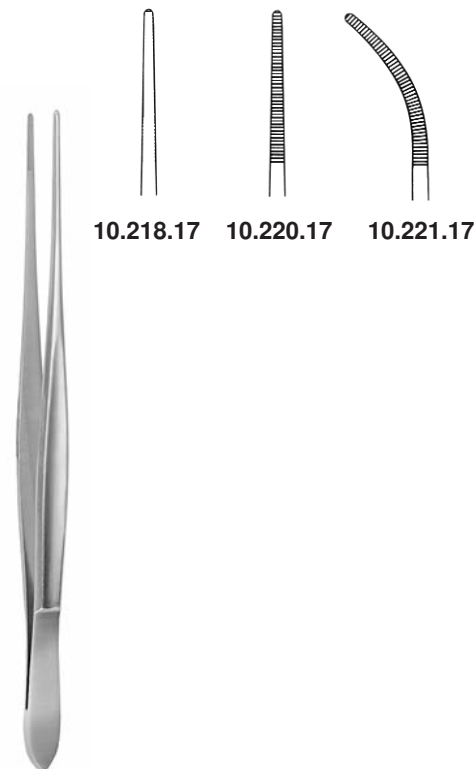

10.218.17

10.220.17

10.221.17

CUSHING  
 17 cm/6¾"

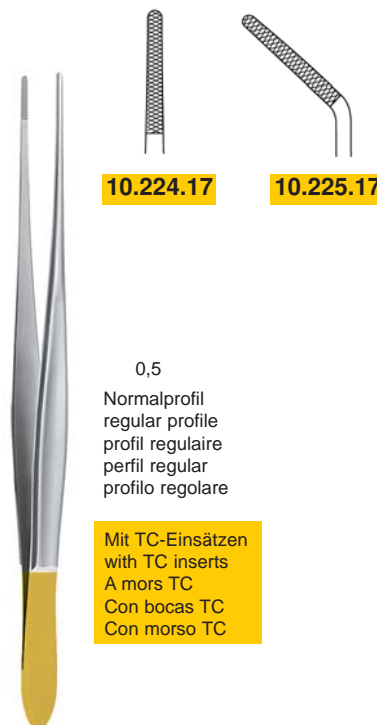

10.224.17

10.225.17

0,5  
 Normalprofil  
 regular profile  
 profil regulare  
 profil regulare  
 perfil regular  
 profilo regolare

Mit TC-Einsätzen  
 with TC inserts  
 A mors TC  
 Con bocas TC  
 Con morso TC

CUSHING  
 17 cm/6¾"



10.230.17

10.231.17

CUSHING  
 17 cm/6¾"

Mit TC-Einsätzen  
 with TC inserts  
 A mors TC  
 Con bocas TC  
 Con morso TC



0,5  
 Normalprofil  
 regular profile  
 profil regulare  
 perfil regular  
 profilo regolare

mit Schaberende  
 with dissector end  
 à rugine  
 con rascador  
 con estremità

**CUSHING-TAYLOR**  
**10.226.18**  
 18,5 cm/7¼"



**GRUENWALD**  
**10.228.18**  
 18,5 cm/7¼"



0,4  
 Miniprofil  
 mini profile  
 profil mini  
 perfil mini  
 profilo mini

Mit TC-Einsätzen  
 with TC inserts  
 A mors TC  
 Con bocas TC  
 Con morso TC

**McINDOE**  
**10.257.15**  
 15 cm/6"



10.258.15 10.259.15  
 fein  
 delicate  
 délicates  
 finas  
 delicate

kreuzgerieft  
 cross serrated  
 mors stries  
 boca estriada  
 e zigrinata

**McINDOE**  
**10.259.15**  
 15 cm/6"



**SEMKEN**

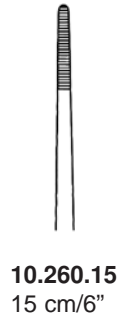

fein  
 delicate  
 délicates  
 finas  
 delicate

**SEMKEN**

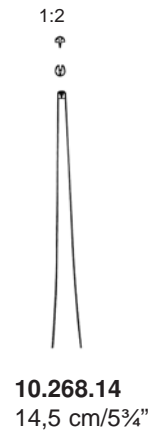

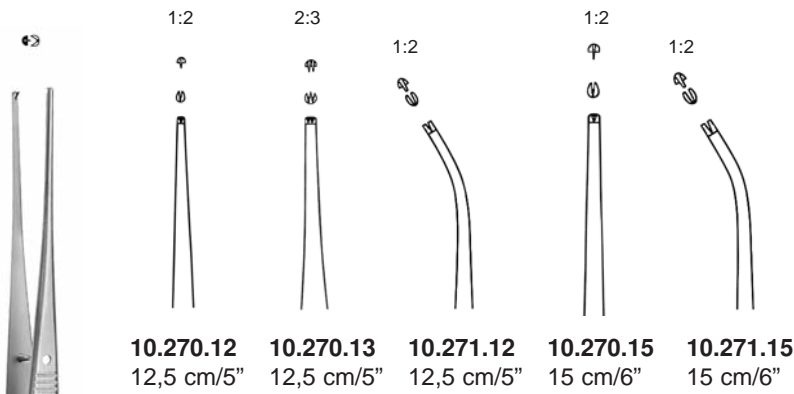

**SEMKEN**

kreuzgerieft  
 cross serrated  
 mors stries  
 boca estriada  
 e zigrinata

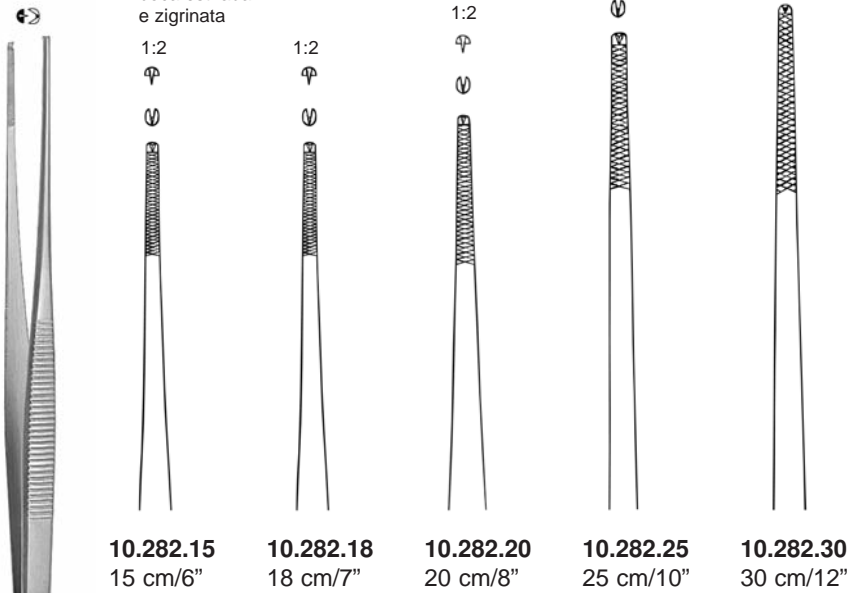

fein  
 delicate  
 délicates  
 finas  
 delicate

**WAUGH**

**GILLIES**  
**10.272.15**  
 15,5 cm/6"



Mit TC-Einsätzen  
 with TC inserts  
 A mors TC  
 Con bocas TC  
 Con morso TC

**GILLIES**  
**10.272.16**  
 15,5 cm/6"

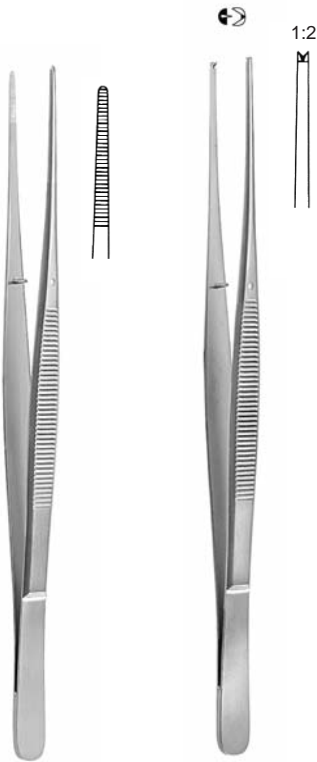

TAYLOR  
**10.274.17**  
 17 cm/6¾"

TAYLOR  
**10.276.17**  
 17,5 cm/7"



TAYLOR  
**10.277.17**  
 18,5 cm/7¼"

mit Schaberende  
 with dissector end  
 à rugine  
 con rascador  
 con estremità a forma di raschino



TAYLOR  
**10.279.17**  
 17 cm/6¾"

mit Schaberende  
 with dissector end  
 à rugine  
 con rascador  
 con estremità a forma di raschino



TAYLOR  
**10.278.17**  
 17 cm/6¾"

mit Schaberende  
 with dissector end  
 à rugine  
 con rascador  
 con estremità a forma di raschino



TAYLOR  
**10.280.17**  
 17 cm/6¾"

mit Schaberende  
 with dissector end  
 à rugine  
 con rascador  
 con estremità a forma di raschino

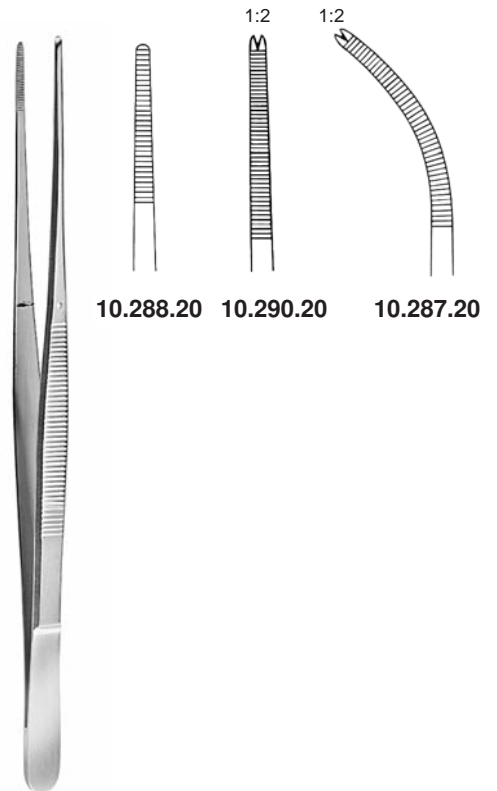

BROPHY  
 20 cm/8"



Pinzetten  
 Thumb and Tissue Forceps  
 Pincès à dissection  
 Pinzas de disección  
 Pinze per dissezione

SURGICAL INSTRUMENTS

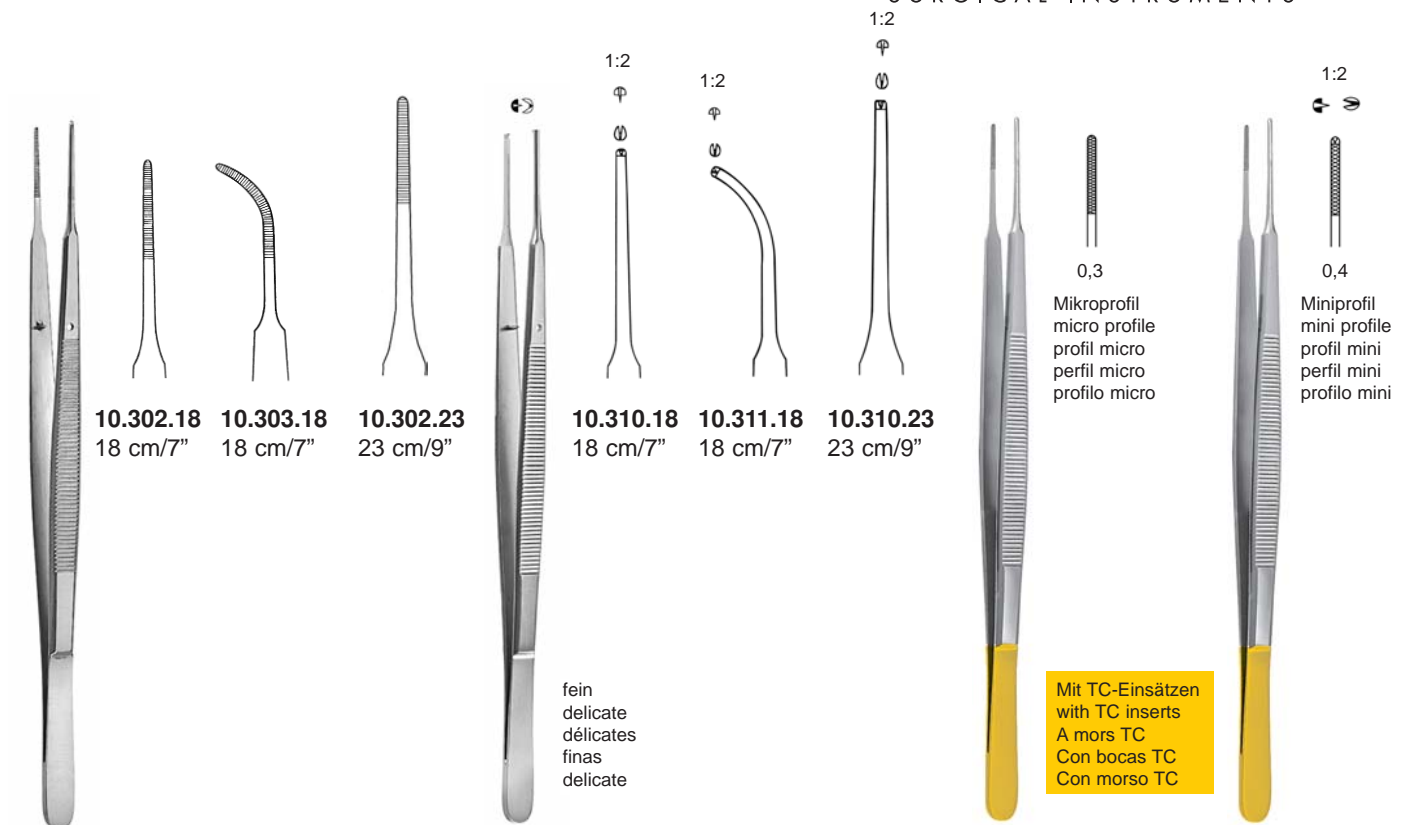

**10.302.18** 18 cm/7"  
**10.303.18** 18 cm/7"  
**10.302.23** 23 cm/9"

**10.310.18** 18 cm/7"  
**10.311.18** 18 cm/7"  
**10.310.23** 23 cm/9"

0,3  
 Mikroprofil  
 micro profile  
 profil micro  
 perfil micro  
 profilo micro

0,4  
 Miniprofil  
 mini profile  
 profil mini  
 perfil mini  
 profilo mini

fein  
 delicate  
 délicates  
 finas  
 delicate

Mit TC-Einsätzen  
 with TC inserts  
 A mors TC  
 Con bocas TC  
 Con morso TC

GERALD

GERALD

GERALD  
**10.304.17**  
 17,5 cm/7"

GERALD  
**10.306.17**  
 17,5 cm/7"

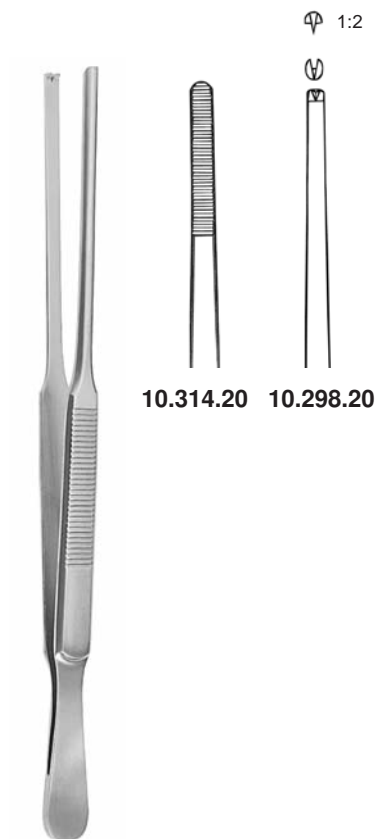

**10.314.20** **10.298.20**

DUEHRSSSEN  
 20 cm/8"



WANGENSTEEN  
 15 cm/6" **10.324.15**  
 23 cm/9" **10.324.23**



Mit TC-Einsätzen  
 with TC inserts  
 A mors TC  
 Con bocas TC  
 Con morso TC

WANGENSTEEN  
 15 cm/6" **10.326.15**  
 23 cm/9" **10.326.23**  
 25 cm/10" **10.326.25**



**10.332.01**  
 12 cm/4¾"  
 Fig. 1



**10.330.12**  
 12 cm/4¾"  
 Fig. 3



**10.330.31**  
 11 cm/4¼"  
 Fig. 3 C

fein  
 delicate  
 délicates  
 finas  
 delicate



**10.332.04**  
 11 cm/4¼"  
 Fig. 4



**10.332.05**  
 11 cm/4¼"  
 Fig. 5

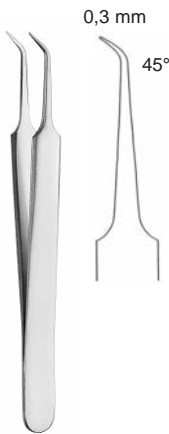

**10.332.45**  
 11 cm/4¼"  
 Fig. 5

0,3 mm  
 45°



**10.333.05**  
 11 cm/4¼"  
 Fig. 5a



**10.332.15**  
 11 cm/4¼"  
 Fig. 6



**10.331.12**  
 12 cm/4¾"  
 Fig. 7



**10.333.11**  
 11,5 cm/4½"



1:2

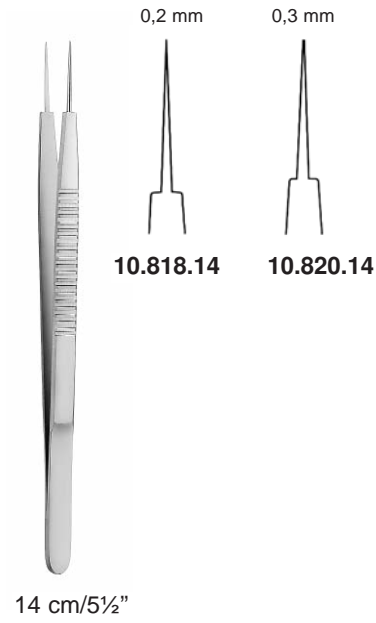



**LUCAE**  
**44.206.14**  
 14 cm/5½"



**JANSEN**  
**44.206.16**  
 16 cm/6¼"



**ADSON**  
**44.206.18**  
 17,5 cm/7"



**LUCAE**  
**44.206.15**  
 14 cm/5½"



**COTTLE**  
**46.581.14**  
 14 cm/5½"

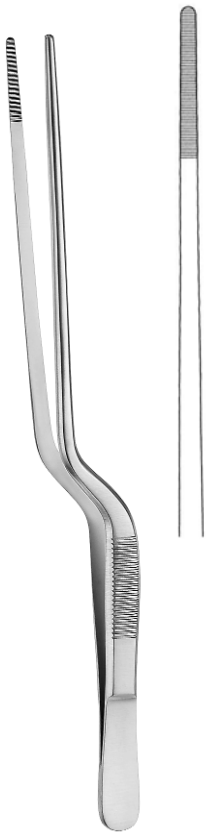

**GRUENWALD**  
**46.154.20**  
 20 cm/8"



**46.156.16**  
 16 cm/6¼"



**46.158.18**  
 18 cm/7¼"

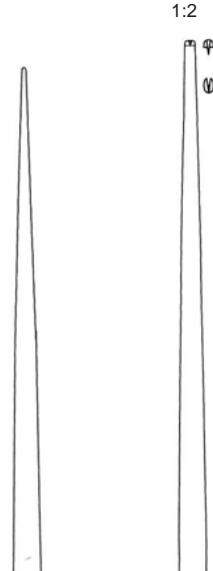

**46.158.19**  
 20 cm/8"