



Arterienklemmen
Hemostatic Forceps
Pinces hémostatiques
Pinzas hemostáticas
Pinze emostatiche

ATRAUMA



DE BAKEY



DE BAKEY



SATINSKY
12.059.07
 7 cm/2¾"



CAROTID
12.061.09
 9 cm/3½"



12.063.10
 10 cm/4"



GLOVER
12.065.06
 5,5 cm/2¼", 35 mm



GLOVER
12.070.35
 3,5 cm/1½"



GLOVER
12.071.35
 3,5 cm/1½"



GLOVER
12.070.45
 4,5 cm/1¾"



GLOVER
12.071.45
 4,5 cm/1¾"



GLOVER
12.070.50
 5 cm/2"



GLOVER
12.071.50
 5 cm/2"

ATRAUMA



DE BAKEY

DE BAKEY-
DIETRICH

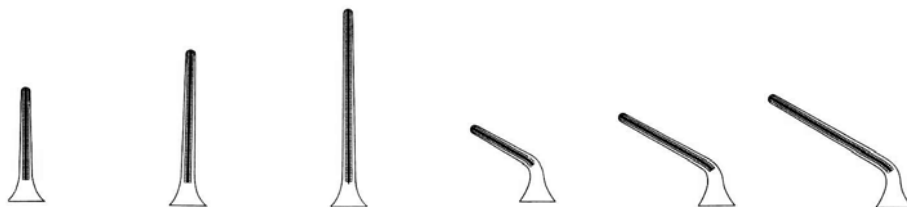

12.078.10 12.078.14 12.078.20 12.079.10 12.079.14 12.079.20

Länge Length Longueur Longitud Lunghezza	5 cm/2"	5 cm/2"	6 cm/2½"	5 cm/2"	5 cm/2"	6 cm/2½"
Maullänge Jaw length Longueur des mors Longitud de la boca Lunghezza del morso	10 mm	14 mm	20 mm	10 mm	14 mm	20 mm
Gewicht Weight Poids Peso Peso	3 gr.	3 gr.	3 gr.	3 gr.	3 gr.	3 gr.
Schließdruck Closing pressure Pression d'occlusion Presión de cierre Pression di chiusura	180 gr.	180 gr.	180 gr.	180 gr.	180 gr.	180 gr.



DIETRICH

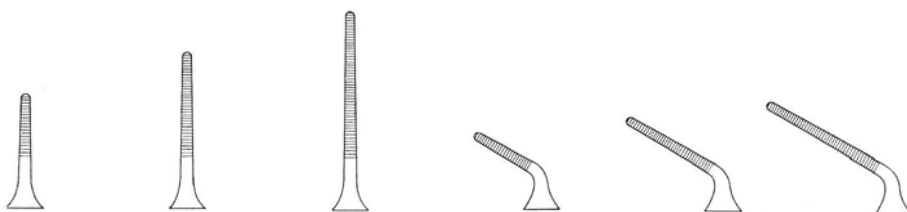

12.082.08 12.082.12 12.082.16 12.083.08 12.083.12 12.083.16

Länge Length Longueur Longitud Lunghezza	5 cm/2"	5 cm/2"	6 cm/2½"	5 cm/2"	5 cm/2"	6 cm/2½"
Maullänge Jaw length Longueur des mors Longitud de la boca Lunghezza del morso	8 mm	12 mm	20 mm	8 mm	12 mm	20 mm
Gewicht Weight Poids Peso Peso	3 gr.	3 gr.	3 gr.	3 gr.	3 gr.	3 gr.
Schließdruck Closing pressure Pression d'occlusion Presión de cierre Pression di chiusura	50 gr.	50 gr.	50 gr.	50 gr.	50 gr.	50 gr.

ATRAUMA



DE BAKEY



DE BAKEY



12.092.07
7,5 cm/3"



12.092.08
8,5 cm/3½"



12.092.10
10,5 cm/4¼"



12.092.12
12 cm/4¾"



12.093.07
7 cm/2¾"



12.093.08
8 cm/3¼"



12.093.10
10 cm/4"

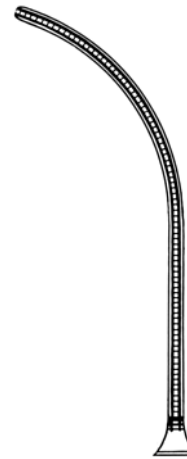

12.093.12
11,5 cm/4¾"

Bulldogklemmen
 Bulldog Clamps
 Clamps Bulldog
 Clamps Bulldog
 Pinze Bulldog

dimed[®]

SURGICAL INSTRUMENTS

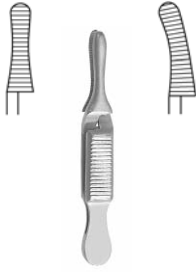

— DIEFFENBACH —

3,5 cm/1½"	12.102.04	12.103.04
5 cm/2"	12.102.05	12.103.05



DE BAKEY-HESS

Maullänge
 Jaw length
 Longueur des mors
 Longitud de la boca
 Lunghezza del morso

12.112.20	12.112.30
20 mm	30 mm



— DIEFFENBACH —

5,8 cm/2¼"	12.104.06	12.105.06
------------	------------------	------------------

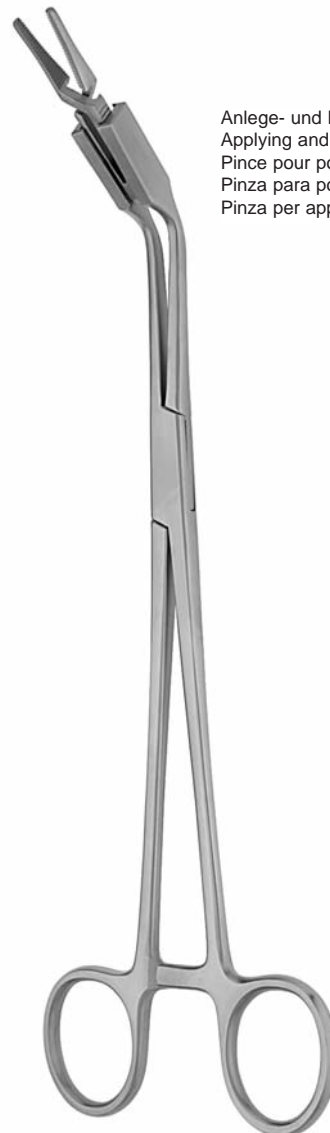

Anlege- und Entfernungszange für Bulldogklemmen
 Applying and removing forceps for Bulldog clamps
 Pince pour poser et retirer les clamps Bulldog
 Pinza para poner y quitar clamps Bulldog
 Pinza per applicare e rimuovere clamps



12.091.23
 23 cm/8¼"

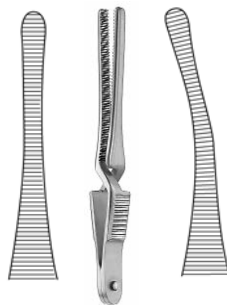

— JOHN-HOPKINS —

5 cm/2"	12.110.50	12.111.50
5,5 cm/2¼"	12.110.55	12.111.55
6,5 cm/2½"	12.110.65	12.111.65
7 cm/2¾"	12.110.70	12.111.70
7,5 cm/3"	12.110.75	12.111.75
9 cm/3½"	12.110.90	12.111.90

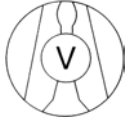

schwache Schließkraft, für Venen
 soft closing pressure, for veins
 force de fermeture faible, pour veines
 fuerza de cierre pequeña, para venas
 forza di chiusura debole, per vene

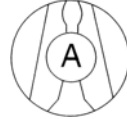

starke Schließkraft, für Arterien
 strong closing pressure, for arteries
 force de fermeture forte, pour artères
 fuerza de cierre grande, para arterias
 forza di chiusura forte, per arterie

	3 cm	3,5 cm	4 cm	5 cm	
Vena	12.132.30	12.132.35	12.132.40	12.132.50	Titan Titanium Titane Titanio Titanio
Artria	12.142.30	12.142.35	12.142.40	12.142.50	



	3 cm	3,5 cm	4 cm	5 cm	
Vena	12.133.30	12.133.35	12.133.40	12.133.50	Titan Titanium Titane Titanio Titanio
Artria	12.143.30	12.143.35	12.143.40	12.143.50	

	3 cm	3,5 cm	4 cm	5 cm	
Vena	12.135.30	12.135.35	12.135.40	12.135.50	Titan Titanium Titane Titanio Titanio
Artria	12.145.30	12.145.35	12.145.40	12.145.50	



TERRIER
12.206.08
 8,5 cm/3¼"



CARREL
12.208.08
 8,5 cm/3¼"



HARTMANN
 10 cm/4"

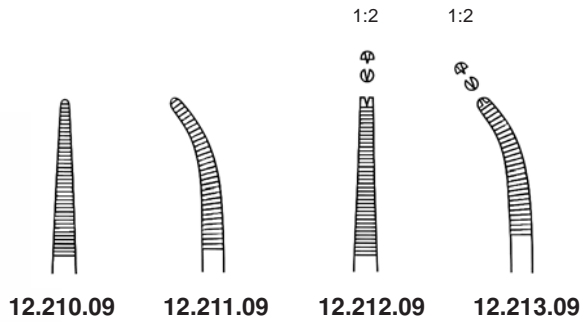

HARTMANN micro
 10 cm/4"

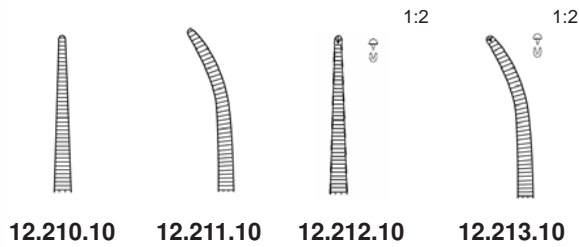



HALSTED-MOSQUITO

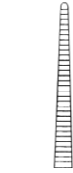

12.220.12
12.224.12
 12,5 cm/5"



12.220.14
 14,5 cm/5¾"



12.221.12
12.225.12
 12,5 cm/5"



12.221.14
 14,5 cm/5½"



12.230.12
12.234.12
 12,5 cm/5"



12.230.14
 14,5 cm/5¾"



12.231.12
12.235.12
 12,5 cm/5"



12.231.14
 14,5 cm/5½"

Titan
 Titanium
 Titane
 Titanio
 Titanio



HALSTED-MOSQUITO micro



12.222.10
 10 cm/4"



12.222.12
 12 cm/4¾"



12.223.10
 10 cm/4"



12.223.12
 12 cm/4¾"



12.232.10
 10 cm/4"



12.232.12
 12 cm/4¾"



12.233.10
 10 cm/4"



12.233.12
 12 cm/4¾"

Titan
 Titanium
 Titane
 Titanio
 Titanio

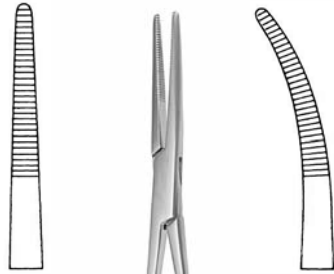

12.240.14
 12.244.14

12.241.14
 12.245.14

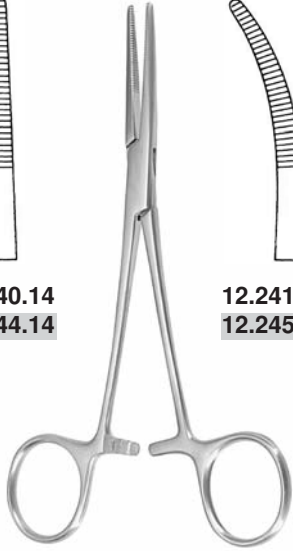

KELLY
 14 cm/5½"



12.242.16

12.243.16

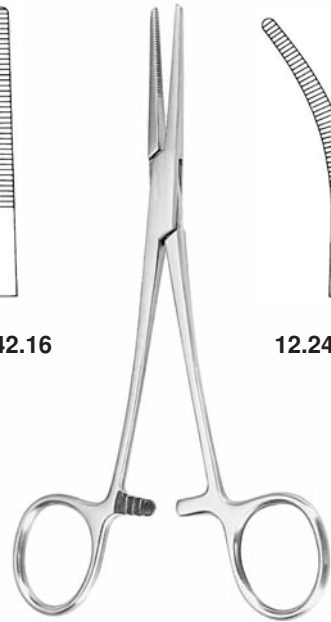

KELLY-RANKIN
 16 cm/6¼"



CRILE
 14 cm/5½"

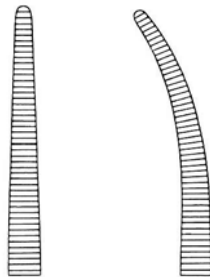

12.250.14
 12.254.14

12.251.14
 12.255.14

1:2

1:2



12.260.14



12.261.14

Titan
 Titanium
 Titane
 Titanio
 Titanio



12.252.14

12.253.14



fein
 delicate
 délicats
 finas
 delicate

CRILE
 14 cm/5½"

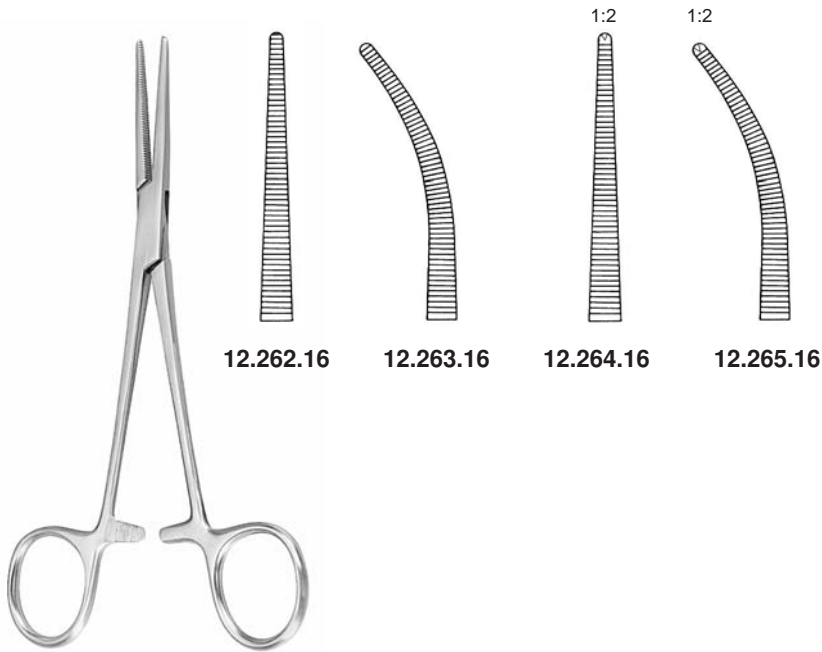

CRILE-RANKIN
 16 cm/6¼"

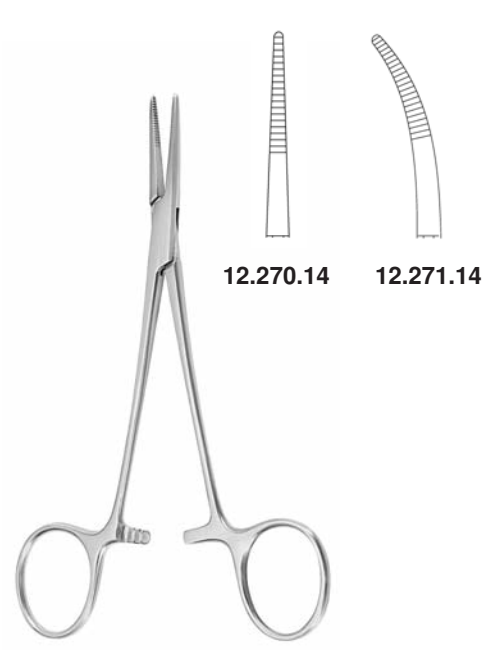

PROVIDENCE-HOSPITAL
 14 cm/5½"



CAIRNS
 15 cm/6"

12,5 cm/5" **DUNHILL**

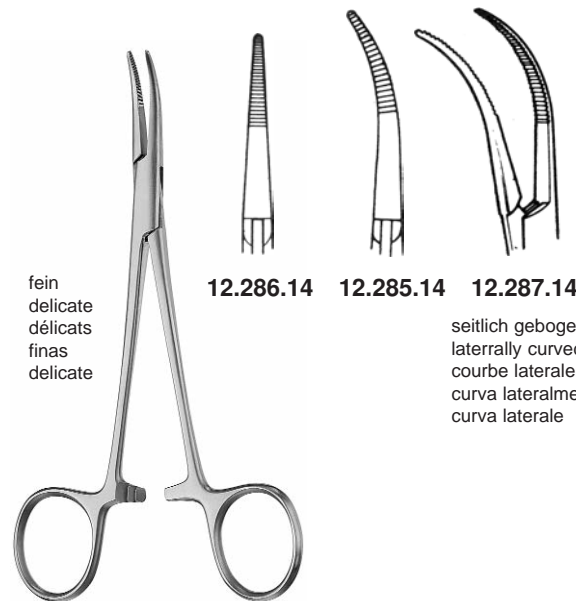

fein
 delicate
 délicats
 finas
 delicate

CUSHING
 14,5 cm/5¾"

seitlich gebogen
 laterally curved
 courbe lateralement
 curva lateralmente
 curva laterale

Kopfhautklemmen
 Scalp Forceps
 Pinces pour cuir chevelu
 Pinzas para el cuero cabelludo
 Pinze per cuoio capelluto

dimed[®]

SURGICAL INSTRUMENTS



MOYNIHAN
 15 cm/6" 12.278.14 12.279.14



MOYNIHAN
 12.279.15
 14,5 cm/5 3/4"

seitlich gebogen
 laterally curved
 courbe lateralement
 curva lateralmente
 curva laterale

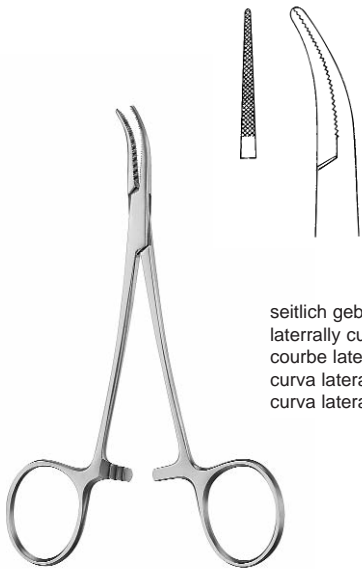

DANDY
 12.345.12
 12 cm/4 3/4"

seitlich gebogen
 laterally curved
 courbe lateralement
 curva lateralmente
 curva laterale

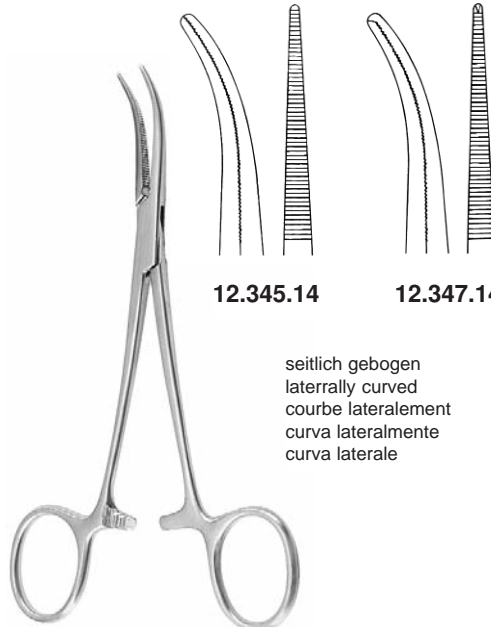

12.345.14

12.347.14

seitlich gebogen
 laterally curved
 courbe lateralement
 curva lateralmente
 curva laterale

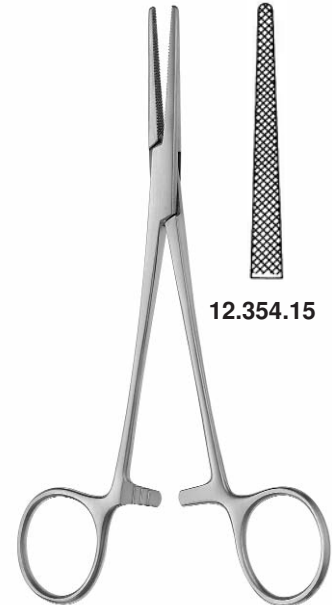

LOVELACE
 12.354.15 12.356.15
 16 cm/6 1/4"

12.354.15

12.356.15

1:2



seitlich gebogen
 laterally curved
 courbe lateralement
 curva lateralmente
 curva laterale

RAIMONDI
12.346.13
 12,5 cm/5"

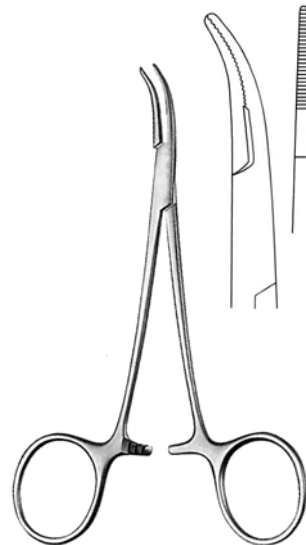

seitlich gebogen
 laterally curved
 courbe lateralement
 curva lateralmente
 curva laterale

HOEN
12.348.14
 13,5 cm/5¼"



MARTEL
12.364.14
 14 cm/5½"



WILLET-MARTEL
12.366.19
 19 cm/7½"

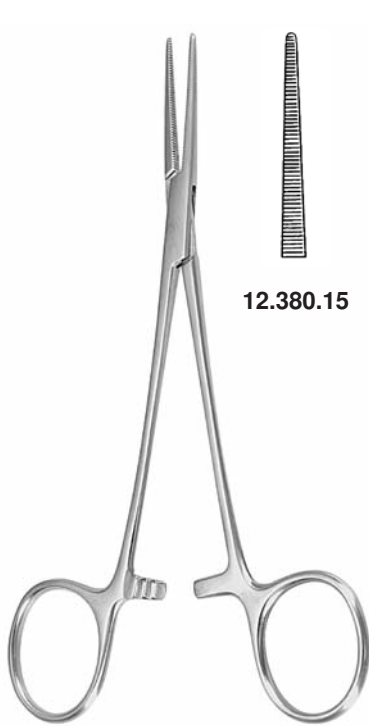

LERICHE
 15 cm/6"

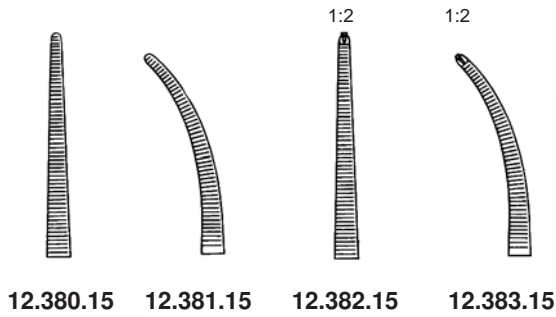

ADSON Baby

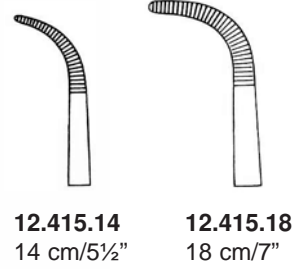

JACOBSON
 12,5 cm/5"

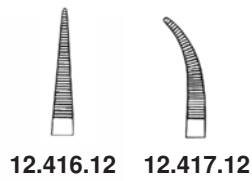

JACOBSON
 18 cm/7"

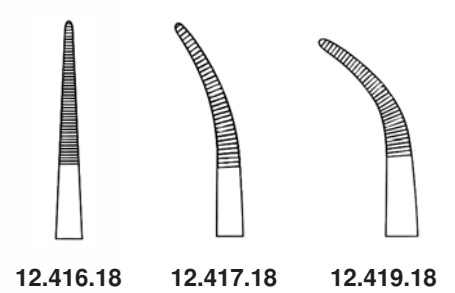



GEMINI

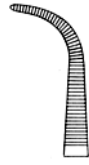

12.431.13
13 cm/5"

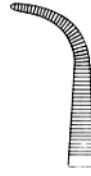

12.431.14
14 cm/5½"

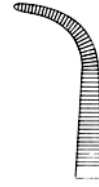

12.431.16
16 cm/6¼"

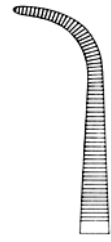

12.431.18
18 cm/7"



12.431.20
20 cm/8"



12.431.23
23 cm/9"



12.431.25
25 cm/10"

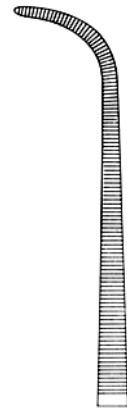

12.431.28
28 cm/11"



GEMINI mini



12.433.18
18 cm/7"



12.433.22
22 cm/8¾"



12.433.25
25 cm/10"

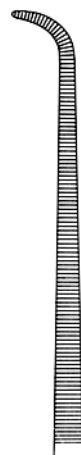

12.433.28
28 cm/11"



12.468.14 12.469.14

Baby MIXTER
 14 cm/5½"

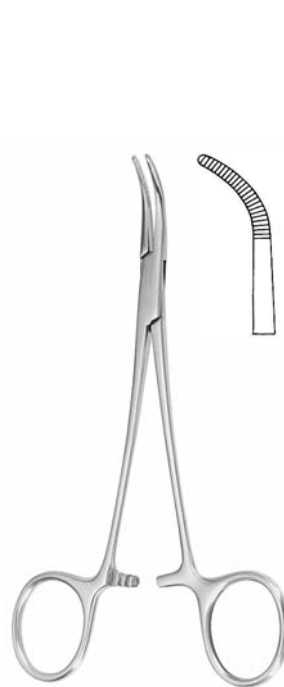

MIXTER Baby
 12.475.14
 14 cm/5½"

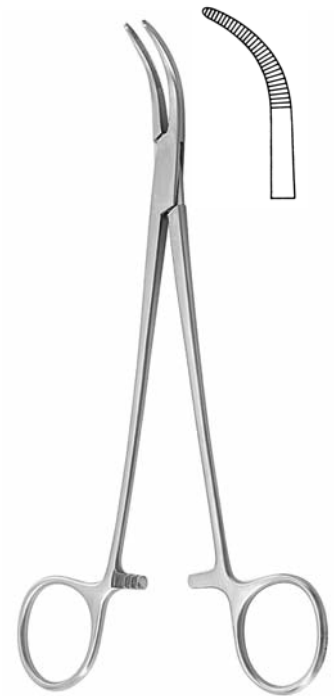

MIXTER Baby
 12.475.18
 18 cm/7"

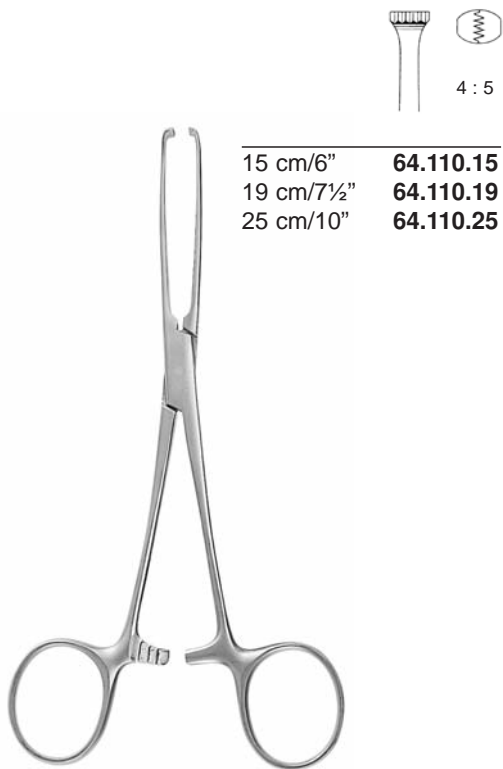

15 cm/6"	64.110.15
19 cm/7½"	64.110.19
25 cm/10"	64.110.25

ALLIS

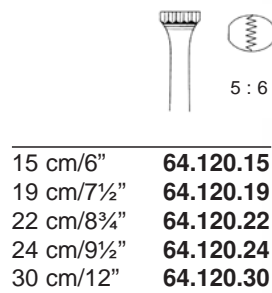

15 cm/6"	64.120.15
19 cm/7½"	64.120.19
22 cm/8¾"	64.120.22
24 cm/9½"	64.120.24
30 cm/12"	64.120.30



64.124.16	64.124.20
16 cm/6¼"	20 cm/8"

64.124.25	64.124.30
25 cm/10"	30 cm/12"

ATRAUMA



DE BAKEY

ALLIS-Atrauma

dimeda[®]

SURGICAL INSTRUMENTS